

75-SERIES MASTER CYL.
3.53 (5/8 TO 3/4 BORE)
3.63 (13/16 TO 1 1/8 BORE)

74-SERIES MASTER CYL.
3.78 (5/8 TO 3/4 BORE)
3.63 (13/16 TO 1 1/8 BORE)

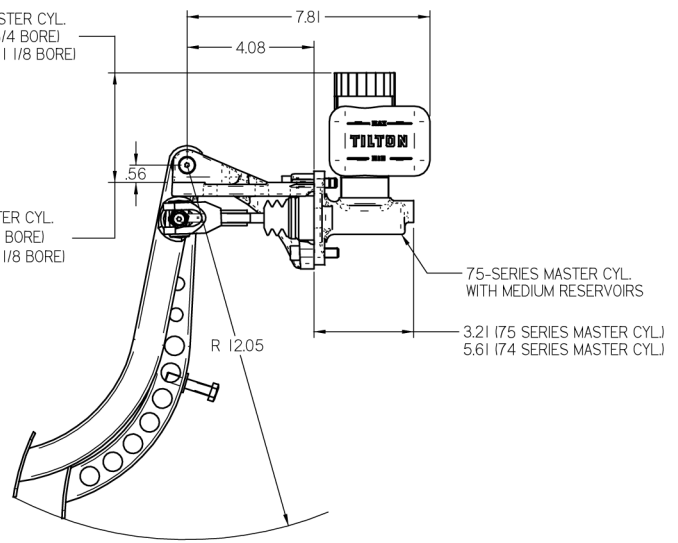

75-SERIES MASTER CYL.
WITH MEDIUM RESERVOIRS

3.21 (75 SERIES MASTER CYL.)
5.61 (74 SERIES MASTER CYL.)



1 PEDAL, 1 MASTER CYLINDER
PEDAL ASSEMBLY
P/N 72-672

1 PEDAL, 2 MASTER CYLINDERS
PEDAL ASSEMBLY
P/N 72-604

2 PEDALS, 3 MASTER CYLINDERS
PEDAL ASSEMBLY
P/N 72-628 NASCAR
P/N 72-629 LIGHTENED

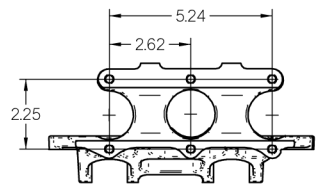
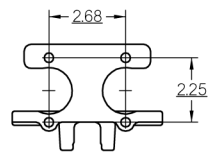
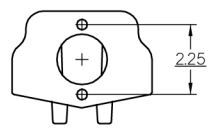
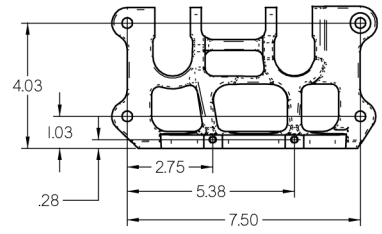
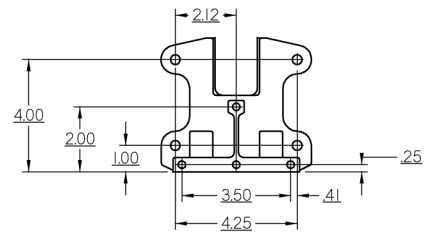
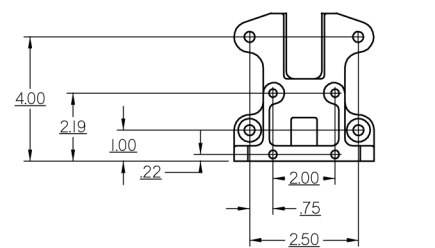

- NOTES:
1. UNLESS SPECIFIED OTHERWISE DIMENSIONS ARE IN INCHES.
 2. DIMENSIONS ARE NOMINAL.
 3. P/N 72-628 SHOWN. P/N 72-629 HAS LIGHTENED BRAKE PEDAL (SIMILAR TO CLUTCH PEDAL).
 4. MASTER CYLINDERS ARE NOT INCLUDED WITH PEDAL ASSEMBLIES.

TILTON ENGINEERING, INC.		(805)688-2353 FAX (805)688-2745	
25 EASY STREET P.O. BOX 1787		BUPELLTON, CALIFORNIA 93427 USA	
TITLE: FIREWALL MOUNT PEDAL ASSEMBLY WITH STEEL BRAKE AND CLUTCH PEDALS			
DRN BY	ROBINSON	CHKD	
P/N	72-XXX	DATE	07/25/02
SCALE 1:1		DWG	
SHEET 1 OF 1			